

ExFeel[®]

External



ExFeel[®] External

Excellent Feeling, Excellent Implant!

Precision External Hex Connection Type 2 Stage Implant

Design Implant thread design maximizes bone contact at the right microscopic level, providing stress dispersion to guarantee surgical outcome. Self tapping threads & the four cutting edges simplify implant placement, and provide strong initial stability.

Surface Our Super RBM Surface Treatment produces a favorable surface topography that has been proven through extensive systematic testing. MegaGen's Super RBM Surface shortens loading time and provides favorable results in any bone quality.

Feature Surgical protocol and bone density determine fixture diameter. Diameters range from $\varnothing 3,3$ – $\varnothing 5,5$ mm

Surgery Our surgical instruments are designed to minimize trauma to the bone and simplify surgical procedures.

Prosthetics A wide array of abutment options produces excellent esthetics and stable prosthetics for every situation, (single or multiple units)

Packaging

Pre-Mount Type : Fixture with Mount and Cover Screw

No-Mount Type : Fixture with Cover Screw

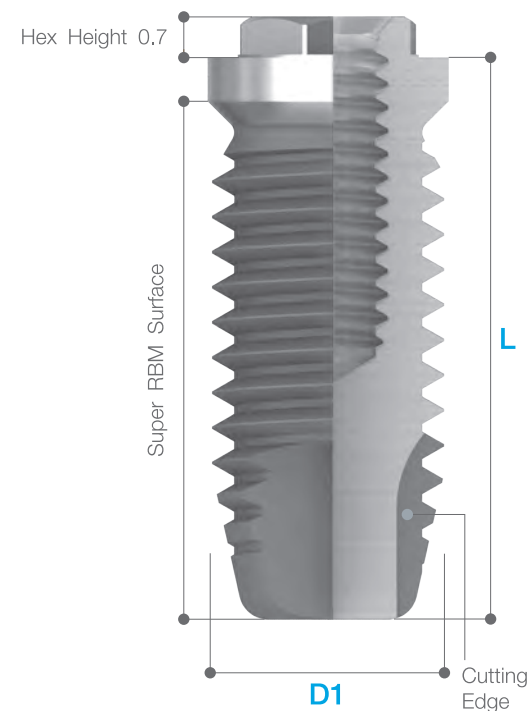
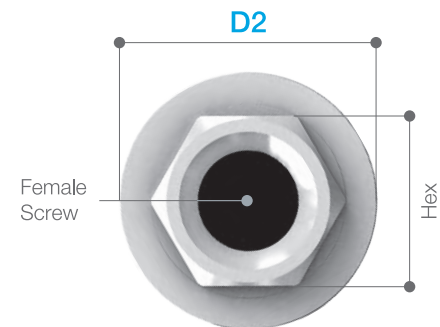















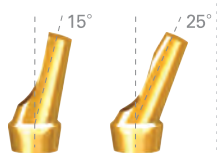





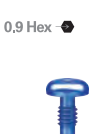



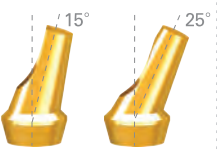



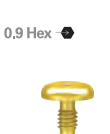

	Small	Regular	Wide
Fixture Mount			
Hex Dimension	2.4	2.7	
D2 Platform Diameter	$\varnothing 3.5$	$\varnothing 4.1$	$\varnothing 5.0$
D1 Thread Diameter	$\varnothing 3.3$	$\varnothing 3.75$ / $\varnothing 4.0$ / $\varnothing 4.5$	$\varnothing 5.0$ / $\varnothing 5.5$
L Fixture Length		7.0 / 8.5 / 10.0 / 11.5 / 13.0 / 15.0mm	

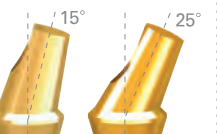
ExFeel[®] External / Abutments

Dental Implant Specialty Company, **MegaGen!**

Ref : Reference Code ■ Small: Interface Diameter=Ø3.5 ■ Regular: Interface Diameter=Ø4.1 ■ Wide: Interface Diameter = Ø5.0 ■ Regular & Wide ■ Hex Type Non-Hex Type Double Hex Interface CH : Cuff Height PD : Profile Diameter PH : Post Height

Cover Screw	Healing Abutment	Esthetic Healing Abutment	Impression Coping [Transfer Type]	Abutment Screw	Gold Abutment	Angled Abutment	EZ Post [PH=8.0mm]	Milling Abutment [PH=9.0mm]	Regular Abutment	Healing Cap	Abutment Screw	EZ Post
 0.9 Hex Ref ■ SDC100	PD: Ø4.0 CH: 2/ 3/ 4/ 5/ 7mm  1.2 Hex	CH: 2/ 3/ 4mm 	 	 1.2 Hex Ø1.6 Ø2.0		 PD: Ø4.0 CH: 2/ 4mm 15° 25°	 PD: Ø4.0 CH: 2/ 4mm	 PD: Ø4.0 CH: 2/ 4mm	CH: 1/ 2/ 3/ 4mm 		 1.2 Hex	
	SDH402 SDH403 SDH404 SDH405 SDH407	AEHS302 AEHS303 AEHS304	SEIN400 REIN500 TEIN600	SCS160 RCS200	SUGA200T SUGA100T RUGA200T RUGA100T TUGA200T TUGA100T	SAA4152T SAA4252T SAA4154T SAA4254T	SCH428T SCN428T SCH448T SCN448T	SCH429T SCN429T SCH449T SCN449T	RDES100 RDE100T RDES200 RDE200T RDES300 RDE300T RDES400 RDE400T	REC600	TASH140	RCA900T RCA800T
 0.9 Hex	PD: Ø5.0/ 6.0 CH: 2/ 3/ 4/ 5/ 7mm  1.2 Hex	CH: 2/ 3/ 4mm 	 Guide Pin	Temporary Abutment 		 PD: Ø5.0 CH: 2/ 4mm 15° 25°	 PD: Ø5.0/ 6.0 CH: 1/ 2/ 3/ 4mm	 PD: Ø5.0/ 6.0 CH: 1/ 2/ 3/ 4mm		 D1=Ø4.8mm D2 D3		
RDC100	RDH502 RDH602 RDH503 RDH603 RDH504 RDH604 RDH505 RDH605 RDH507 RDH607	AEHR402 AEHR403 AEHR404	SEI400T SEIG100 SEIG150 REI4500T REIG100 REIG150 TEI4600T REIG100 REIG150	EZTH330T EZTN330T EZTH400T EZTN400T EZTH500T EZTN500T		RAA5152T RAA5252T RAA5154T RAA5254T	RCH518T RCN518T RCH618T RCN618T RCH528T RCN528T RCH628T RCN628T RCH538T RCN538T RCH638T RCN638T RCH548T RCN548T RCH648T RCN648T	RCH519T RCN519T RCH619T RCN619T RCH529T RCN529T RCH629T RCN629T RCH539T RCN539T RCH639T RCN639T RCH549T RCN549T RCH649T RCN649T		RITE480	ETH100T ETN100T	
	PD: Ø6.0 CH: 2/ 3/ 4/ 5/ 7mm  0.9 Hex	CH: 2/ 3/ 4mm 	 Guide Pin	Lab Analog 		 PD: Ø6.0 CH: 2/ 4mm 15° 25°	 PD: Ø6.0 CH: 1/ 2/ 3/ 4mm	 PD: Ø6.0 CH: 1/ 2/ 3/ 4mm		CH: 1/ 2/ 3/ 4mm  Guide Pin		
TWC100	TWH602 TWH603 TWH604 TWH605 TWH607	AEHW502 AEHW503 AEHW504	SIUH400T SIUN400T SIUG150 RIUH500T RIUN500T RIUG150 TIUH600T TIUN600T TIUG150	SULA300 RULA300 TULA300		TWAA6152T TWAA6252T TWAA6154T TWAA6254T	TWC618T TWCN618T TWC628T TWCN628T TWC638T TWCN638T TWC648T TWCN648T	TWC619T TWCN619T TWC629T TWCN629T TWC639T TWCN639T TWC649T TWCN649T		RDES100 WDT100T RDES200 WDT200T RDES300 WDT300T RDES400 WDT400T	RICG150 RIEH480T RIEN480T	RELA300 REGC200T REGC100T



■ ExFeel External Fixture

Fixture [Pre-Mount]		
Ref. Code	Description	Page
SDR3307P	Small / 3.3 x 7.0mm	p1
SDR3308P	Small / 3.3 x 8.5mm	
SDR3310P	Small / 3.3 x 10.0mm	
SDR3311P	Small / 3.3 x 11.5mm	
SDR3313P	Small / 3.3 x 13.0mm	
SDR3315P	Small / 3.3 x 15.0mm	
RDR3707P	Regular / 3.75 x 7.0mm	p1
RDR3708P	Regular / 3.75 x 8.5mm	
RDR3710P	Regular / 3.75 x 10.0mm	
RDR3711P	Regular / 3.75 x 11.5mm	
RDR3713P	Regular / 3.75 x 13.0mm	
RDR3715P	Regular / 3.75 x 15.0mm	
RDR4007P	Regular / 4.0 x 7.0mm	p1
RDR4008P	Regular / 4.0 x 8.5mm	
RDR4010P	Regular / 4.0 x 10.0mm	
RDR4011P	Regular / 4.0 x 11.5mm	
RDR4013P	Regular / 4.0 x 13.0mm	
RDR4015P	Regular / 4.0 x 15.0mm	
RDR4507P	Regular / 4.5 x 7.0mm	p1
RDR4508P	Regular / 4.5 x 8.5mm	
RDR4510P	Regular / 4.5 x 10.0mm	
RDR4511P	Regular / 4.5 x 11.5mm	
RDR4513P	Regular / 4.5 x 13.0mm	
RDR4515P	Regular / 4.5 x 15.0mm	
TWDR5007P	Wide / 5.0 x 7.0mm	p1
TWDR5008P	Wide / 5.0 x 8.5mm	
TWDR5010P	Wide / 5.0 x 10.0mm	
TWDR5011P	Wide / 5.0 x 11.5mm	
TWDR5013P	Wide / 5.0 x 13.0mm	
TWDR5015P	Wide / 5.0 x 15.0mm	
TWDR5507P	Wide / 5.5 x 7.0mm	p1
TWDR5508P	Wide / 5.5 x 8.5mm	
TWDR5510P	Wide / 5.5 x 10.0mm	
TWDR5511P	Wide / 5.5 x 11.5mm	
TWDR5513P	Wide / 5.5 x 13.0mm	
TWDR5515P	Wide / 5.5 x 15.0mm	
Fixture [No-Mount]		
SDR3307C	Small / 3.3 x 7.0mm	p1
SDR3308C	Small / 3.3 x 8.5mm	
SDR3310C	Small / 3.3 x 10.0mm	
SDR3311C	Small / 3.3 x 11.5mm	
SDR3313C	Small / 3.3 x 13.0mm	
SDR3315C	Small / 3.3 x 15.0mm	
RDR3707C	Regular / 3.75 x 7.0mm	p1
RDR3708C	Regular / 3.75 x 8.5mm	
RDR3710C	Regular / 3.75 x 10.0mm	
RDR3711C	Regular / 3.75 x 11.5mm	
RDR3713C	Regular / 3.75 x 13.0mm	
RDR3715C	Regular / 3.75 x 15.0mm	

Ref. Code	Description	Page
RDR4007C	Regular / 4.0 x 7.0mm	p1
RDR4008C	Regular / 4.0 x 8.5mm	
RDR4010C	Regular / 4.0 x 10.0mm	
RDR4011C	Regular / 4.0 x 11.5mm	
RDR4013C	Regular / 4.0 x 13.0mm	
RDR4015C	Regular / 4.0 x 15.0mm	
RDR4507C	Regular / 4.5 x 7.0mm	p1
RDR4508C	Regular / 4.5 x 8.5mm	
RDR4510C	Regular / 4.5 x 10.0mm	
RDR4511C	Regular / 4.5 x 11.5mm	
RDR4513C	Regular / 4.5 x 13.0mm	
RDR4515C	Regular / 4.5 x 15.0mm	
TWDR5007C	Wide / 5.0 x 7.0mm	p1
TWDR5008C	Wide / 5.0 x 8.5mm	
TWDR5010C	Wide / 5.0 x 10.0mm	
TWDR5011C	Wide / 5.0 x 11.5mm	
TWDR5013C	Wide / 5.0 x 13.0mm	
TWDR5015C	Wide / 5.0 x 15.0mm	
TWDR5507C	Wide / 5.5 x 7.0mm	p1
TWDR5508C	Wide / 5.5 x 8.5mm	
TWDR5510C	Wide / 5.5 x 10.0mm	
TWDR5511C	Wide / 5.5 x 11.5mm	
TWDR5513C	Wide / 5.5 x 13.0mm	
TWDR5515C	Wide / 5.5 x 15.0mm	

■ Instrument

Instrument		
MGD100L	Lance Drill	p2
TEEL200M	Lindermann Drill	
MDE150	Drill Extension	
TEED2007	Twist Drill / Ø2.0 Stopper / 7.0mm	p2
TEED2008	Twist Drill / Ø2.0 Stopper / 8.5mm	
TEED2010	Twist Drill / Ø2.0 Stopper / 10.0mm	
TEED2011	Twist Drill / Ø2.0 Stopper / 11.5mm	
TEED2807	Shaping Drill / Ø2.8 Stopper / 7.0mm	
TEED2808	Shaping Drill / Ø2.8 Stopper / 8.5mm	
TEED2810	Shaping Drill / Ø2.8 Stopper / 10.0mm	
TEED2811	Shaping Drill / Ø2.8 Stopper / 11.5mm	
MHD090S	Hand Driver 0.9 Hex / Short	p2
MHD090L	Hand Driver 0.9 Hex / Long	
MHD120S	Hand Driver 1.2 Hex / Short	
MHD120L	Hand Driver 1.2 Hex / Long	
MD1100	Direction Indicator	
MOW300	Open Wrench	
MRW040S	Ratchet Wrench	
MPD2833L	Pilot Drill / Ø2.0, Ø2.8, Ø3.3	p2
MPD3843L	Pilot Drill / Ø3.3, Ø3.8, Ø4.3	
MCS330	Countersink For Ø3.3 Fixture	p2
MCS375	Countersink For Ø3.75 & Ø4.0 Fixture	



ExFeel[®] External

Dental Implant Specialty Company, MegaGen!

CH : Cuff Height PD : Profile Diameter

Ref. Code	Description	Page
TEED200M	Twist Drill / D 2.0	p2
TEED280M	Straight Drill / D 2.8	
TEED330M	Straight Drill / D 3.3	
TEED380M	Straight Drill / D 3.8	
TEED430M	Straight Drill / D 4.3	
TEED480M	Straight Drill / D 4.8	
MTP330L	Tap For Small Ø3.3 Fixture	p2
MTP375L	Tap For Regular Ø3.75 Fixture	
MTP400L	Tap For Regular Ø4.0 Fixture	
MTP450L	Tap For Regular Ø4.5 Fixture	
MTP500S	Tap For Wide Ø5.0 Fixture	
MTP550S	Tap For Wide Ø5.5 Fixture	
SMFO012T	Fixture Long Mount / Small / 12mm	p2
RMFO012T	Fixture Long Mount / R & W / 12mm	
MMD310	Handpiece Connector	p2
MMT310S	Ratchet Extension / Short	
MMT310L	Ratchet Extension / Long	

■ Abutment

Fixture Mount

SMFO002T	Fixture Mount / Small	p3
RMFO002T	Fixture Mount / Regular	
TMFO002T	Fixture Mount / Wide	
SMFS002	Mount Screw / Small	
TMFS002	Mount Screw / Regular & Wide	

Cover Screw

SDC100	Small	p3
RDC100	Regular	
TWC100	Wide	

Healing Abutment

SDH402	Small / PD=Ø4.0 / CH=2.0mm	p3
SDH403	Small / PD=Ø4.0 / CH=3.0mm	
SDH404	Small / PD=Ø4.0 / CH=4.0mm	
SDH405	Small / PD=Ø4.0 / CH=5.0mm	
SDH407	Small / PD=Ø4.0 / CH=7.0mm	
RDH502	Regular / PD=Ø5.0 / CH=2.0mm	p3
RDH503	Regular / PD=Ø5.0 / CH=3.0mm	
RDH504	Regular / PD=Ø5.0 / CH=4.0mm	
RDH505	Regular / PD=Ø5.0 / CH=5.0mm	
RDH507	Regular / PD=Ø5.0 / CH=7.0mm	
RDH602	Regular / PD=Ø6.0 / CH=2.0mm	p3
RDH603	Regular / PD=Ø6.0 / CH=3.0mm	
RDH604	Regular / PD=Ø6.0 / CH=4.0mm	
RDH605	Regular / PD=Ø6.0 / CH=5.0mm	
RDH607	Regular / PD=Ø6.0 / CH=7.0mm	
TWH602	Wide / PD=Ø6.0 / CH=2.0mm	p3
TWH603	Wide / PD=Ø6.0 / CH=3.0mm	
TWH604	Wide / PD=Ø6.0 / CH=4.0mm	
TWH605	Wide / PD=Ø6.0 / CH=5.0mm	
TWH607	Wide / PD=Ø6.0 / CH=7.0mm	

Impression Coping

Ref. Code	Description	Page
SEIN400	Imp. Coping / Small / Transfer / Non-Hex	p3
SEIH400T	Imp. Coping / Small / Transfer / Hex	
REIN500	Imp. Coping / Regular / Transfer / Non-Hex	
REIH500T	Imp. Coping / Regular / Transfer / Hex	
TEIN600	Imp. Coping / Wide / Transfer / Non-Hex	
TEIH600T	Imp. Coping / Wide / Transfer / Hex	
SEIG100	Guide Pin / Small / 10mm	
SEIG150	Guide Pin / Small / 15mm	
REIG100	Guide Pin / Regular & Wide / 10mm	
REIG150	Guide Pin / Regular & Wide / 15mm	
SIUN400T	Imp. Coping / Small / Pick-Up / Non-Hex	p3
SIUH400T	Imp. Coping / Small / Pick-Up / Hex	
RIUN500T	Imp. Coping / Regular / Pick-Up / Non-Hex	
RIUH500T	Imp. Coping / Regular / Pick-Up / Hex	
TIUN600T	Imp. Coping / Wide / Pick-Up / Non-Hex	
TIUH600T	Imp. Coping / Wide / Pick-Up / Hex	
SIUG150	Guide Pin / Small / 15mm	
RIUG150	Guide Pin / Regular & Wide / 15mm	

Lab Analog

SULA300	Small	p3
RULA300	Regular	
TULA300	Wide	

Abutment Screw

SCS160	Small	p3
RCS200	Regular & Wide	

Temporary Abutment

EZTN330T	Small / Non-Hex	p3
EZTH330T	Small / Hex	
EZTN400T	Regular / Non-Hex	
EZTH400T	Regular / Hex	
EZTN500T	Wide / Non-Hex	
EZTH500T	Wide / Hex	

EZ Post [PH=8.0mm]

SCN428T	Small / PD=Ø4.0 / CH=2.0mm / Non-Hex	p3
SCN448T	Small / PD=Ø4.0 / CH=4.0mm / Non-Hex	
SCH428T	Small / PD=Ø4.0 / CH=2.0mm / Hex	
SCH448T	Small / PD=Ø4.0 / CH=4.0mm / Hex	
RCN518T	Regular / PD=Ø5.0 / CH=1.0mm / Non-Hex	p3
RCN528T	Regular / PD=Ø5.0 / CH=2.0mm / Non-Hex	
RCN538T	Regular / PD=Ø5.0 / CH=3.0mm / Non-Hex	
RCN548T	Regular / PD=Ø5.0 / CH=4.0mm / Non-Hex	
RCN618T	Regular / PD=Ø6.0 / CH=1.0mm / Non-Hex	p3
RCN628T	Regular / PD=Ø6.0 / CH=2.0mm / Non-Hex	
RCN638T	Regular / PD=Ø6.0 / CH=3.0mm / Non-Hex	
RCN648T	Regular / PD=Ø6.0 / CH=4.0mm / Non-Hex	
RCH518T	Regular / PD=Ø5.0 / CH=1.0mm / Hex	p3
RCH528T	Regular / PD=Ø5.0 / CH=2.0mm / Hex	
RCH538T	Regular / PD=Ø5.0 / CH=3.0mm / Hex	
RCH548T	Regular / PD=Ø5.0 / CH=4.0mm / Hex	



ExFeel[®] External

Dental Implant Specialty Company, MegaGen!

CH : Cuff Height PD : Profile Diameter

Ref. Code	Description	Page
RCH618T	Regular / PD=Ø6.0 / CH=1.0mm / Hex	p3
RCH628T	Regular / PD=Ø6.0 / CH=2.0mm / Hex	
RCH638T	Regular / PD=Ø6.0 / CH=3.0mm / Hex	
RCH648T	Regular / PD=Ø6.0 / CH=4.0mm / Hex	
TWCN618T	Wide / PD=Ø6.0 / CH=1.0mm / Non-Hex	p3
TWCN628T	Wide / PD=Ø6.0 / CH=2.0mm / Non-Hex	
TWCN638T	Wide / PD=Ø6.0 / CH=3.0mm / Non-Hex	
TWCN648T	Wide / PD=Ø6.0 / CH=4.0mm / Non-Hex	
TWCH618T	Wide / PD=Ø6.0 / CH=1.0mm / Hex	p3
TWCH628T	Wide / PD=Ø6.0 / CH=2.0mm / Hex	
TWCH638T	Wide / PD=Ø6.0 / CH=3.0mm / Hex	
TWCH648T	Wide / PD=Ø6.0 / CH=4.0mm / Hex	
Milling Abutment [PH=9.0mm]		
SCN429T	PD=Ø4.0 / CH=2.0mm / Small / Non-Hex	p3
SCN449T	PD=Ø4.0 / CH=4.0mm / Small / Non-Hex	
SCH429T	PD=Ø4.0 / CH=2.0mm / Small / Hex	
SCH449T	PD=Ø4.0 / CH=4.0mm / Small / Hex	
RCN519T	PD=Ø5.0 / CH=1.0mm / Regular / Non-Hex	p3
RCN529T	PD=Ø5.0 / CH=2.0mm / Regular / Non-Hex	
RCN539T	PD=Ø5.0 / CH=3.0mm / Regular / Non-Hex	
RCN549T	PD=Ø5.0 / CH=4.0mm / Regular / Non-Hex	
RCH519T	PD=Ø5.0 / CH=1.0mm / Regular / Hex	p3
RCH529T	PD=Ø5.0 / CH=2.0mm / Regular / Hex	
RCH539T	PD=Ø5.0 / CH=3.0mm / Regular / Hex	
RCH549T	PD=Ø5.0 / CH=4.0mm / Regular / Hex	
RCN619T	PD=Ø6.0 / CH=1.0mm / Regular / Non-Hex	p3
RCN629T	PD=Ø6.0 / CH=2.0mm / Regular / Non-Hex	
RCN639T	PD=Ø6.0 / CH=3.0mm / Regular / Non-Hex	
RCN649T	PD=Ø6.0 / CH=4.0mm / Regular / Non-Hex	
RCH619T	PD=Ø6.0 / CH=1.0mm / Regular / Hex	p3
RCH629T	PD=Ø6.0 / CH=2.0mm / Regular / Hex	
RCH639T	PD=Ø6.0 / CH=3.0mm / Regular / Hex	
RCH649T	PD=Ø6.0 / CH=4.0mm / Regular / Hex	
TWCN619T	PD=Ø6.0 / CH=1.0mm / Wide / Non-Hex	p3
TWCN629T	PD=Ø6.0 / CH=2.0mm / Wide / Non-Hex	
TWCN639T	PD=Ø6.0 / CH=3.0mm / Wide / Non-Hex	
TWCN649T	PD=Ø6.0 / CH=4.0mm / Wide / Non-Hex	
TWCH619T	PD=Ø6.0 / CH=1.0mm / Wide / Hex	p3
TWCH629T	PD=Ø6.0 / CH=2.0mm / Wide / Hex	
TWCH639T	PD=Ø6.0 / CH=3.0mm / Wide / Hex	
TWCH649T	PD=Ø6.0 / CH=4.0mm / Wide / Hex	
Gold Abutment		
SUGA100T	Small / Non-Hex	p3
SUGA200T	Small / Hex	
RUGA100T	Regular / Non-Hex	p3
RUGA200T	Regular / Hex	
TUGA100T	Wide / Non-Hex	p3
TUGA200T	Wide / Hex	

Plastic Abutment		
Ref. Code	Description	Page
SUPN100T	Small / Non-Hex	p3
SUPH100T	Small / Hex	
RUPN100T	Regular / Non-Hex	p3
RUPH100T	Regular / Hex	
TUPN100T	Wide / Non-Hex	p3
TUPH100T	Wide / Hex	
Angled Abutment		
SAA4152T	PD=Ø4.0 / CH=2.0mm / Small / 15°	p3
SAA4154T	PD=Ø4.0 / CH=4.0mm / Small / 15°	
SAA4252T	PD=Ø4.0 / CH=2.0mm / Small / 25°	
SAA4254T	PD=Ø4.0 / CH=4.0mm / Small / 25°	
RAA5152T	PD=Ø5.0 / CH=2.0mm / Regular / 15°	p3
RAA5154T	PD=Ø5.0 / CH=4.0mm / Regular / 15°	
RAA5252T	PD=Ø5.0 / CH=2.0mm / Regular / 25°	
RAA5254T	PD=Ø5.0 / CH=4.0mm / Regular / 25°	
TWAA6152T	PD=Ø6.0 / CH=2.0mm / Wide / 15°	p3
TWAA6154T	PD=Ø6.0 / CH=4.0mm / Wide / 15°	
TWAA6252T	PD=Ø6.0 / CH=2.0mm / Wide / 25°	
TWAA6254T	PD=Ø6.0 / CH=4.0mm / Wide / 25°	
Esthetic Type		
RDE100T	Regular Abutment / CH=1.0mm	p3
RDE200T	Regular Abutment / CH=2.0mm	
RDE300T	Regular Abutment / CH=3.0mm	
RDE400T	Regular Abutment / CH=4.0mm	
WDT100T	Wide Abutment / CH=1.0mm	p3
WDT200T	Wide Abutment / CH=2.0mm	
WDT300T	Wide Abutment / CH=3.0mm	
WDT400T	Wide Abutment / CH=4.0mm	
RDES100	Abutment Screw / 1.0mm	p3
RDES200	Abutment Screw / 2.0mm	
RDES300	Abutment Screw / 3.0mm	
RDES400	Abutment Screw / 4.0mm	
REC600	Healing Cap	p3
RITE480	Impression Coping / Transfer	p3
RIEN480T	Impression Coping / Pick-Up / Non-Hex	
RIEH480T	Impression Coping / Pick-Up / Hex	
RICG150	Guide Pin / 15mm	
RELA300	Lab Analog	p3
TASH140	Abutment Screw	p3
ETN100T	Temporary Abutment / Non-Hex	p3
ETH100T	Temporary Abutment / Hex	
RCA800T	EZ Post / Non-Hex	p3
RCA900T	EZ Post / Hex	
REGC100T	Gold Abutment / Non-Hex	p3
REGC200T	Gold Abutment / Hex	

Fixture

Instrument

Abutment

Ref. Code



Customer Service

[HEAD OFFICE] www.imegagen.com

MEGAGEN IMPLANT CO.,LTD

472, HANJANGGUN-RO, JAIN-MYUN, GYEONGSAN, GYEONGBUK, KOREA, 712-852
5F MegaGen Tower, 607 Seolleung-ro, Gangnam-gu, Seoul, Korea
Tel: 82-53-857-5770
Fax: 82-53-857-5432
E-mail: sales@imegagen.com

[Megagen USA INC.] / USA

440 Sylvan Ave. Suite 200 Englewood Cliffs, NJ 07632, USA
Tel : (+1)866-277-5662
E-mail : info@megagenus.com

[ISG Dental GmbH] / Austria

Wiegelestrasse 10, 1230 Vienna, AUSTRIA
Tel : (+43)1869-3220
E-mail : r.schultschik@isg-gmbh.at

[Implant2dentist] / Denmark

Tandlaegerne i kogade I/S Kogade 4 6270 Toender Denmark
Tel : (+45)7010-8700, (+45)2835-5459
E-mail : mikkelro@implant2dentist.dk

[Megagen Hellas LTD] / Greece

19th G. Papandreou Str., 15773 Zografou, Athens, GREECE
Tel : (+30)21-0748-5533, (+30)21-0748-5544
E-mail : george.kouratiadis@dentomedica.gr

[MegaGen Italia S.R.L.] / Italy

VIA MAZZINI 43/b - 22030 Pusiano (Co), ITALY
Tel : (+39)34-8085-5432
E-mail : info@megagenitalia.it

[UAB "ImplaMedica"] / Lithuania

Kalvariju 272, LT-08316 Vilnius, Republic of Lithuania
Tel : (+37)5219-5971
E-mail : info@implamedica.lt

[MegaGen Benelux b.v.] / Netherlands

Prof. Cobbenhagenlaan 99, 5037 DB Tilburg, The Netherlands
Tel : (+31)8-8848-4100, (+31)6-2000-9582
E-mail : info@megagenbenelux.nl

[Megagen Portugal Lda] / Portugal

Rua dos Açores 67, 4430-643 Vila Nova de Gaia, Portugal
Tel : (+351)2-2488-4026
E-mail : geral@megagen.pt

[MEGAGEN DENTAL IMPLANT] / Romania

STR. Mamulari nr.4, BIC2, sc.2, ap.37 sec.3, Bucuresti
Tel : (+40)3-1418-1238
E-mail : ciprian.amarandei@megagen.ro

[Createch Medical SL] / Spain

Pol. Kurutz Gain, Pab 3 20850 Mendaro (Guipúzcoa), Spain
Tel : (+34)9-4375-7172
E-mail : createch@createchmedical.com

[Orexa Dental AB] / Sweden

Berggrensgatan 8, 412 73 Gothenburg, Sweden
Tel: (+46)709-208000
E-mail : info@orexa.se

[Megagen Implants UK] / United Kingdom

Hemel Business Centre Westside, London Road Apsley Hemel Hempstead Herts HP3 9TD UK
Tel : (+44)14-4284-0326
E-mail : dima.corduneanu@megagen.co.uk

[Abtin Pezeshk Abzar Co.] / Iran

Unit 12, 3th Floor, building pezashkan sabz 2 (No8), Imam zadeh Alley, Opposite Dowlat St,Shariati,Tehran-Iran
Tel : (+98)21-26600568-70 / Fax : (+98)21-22612438
E-mail : apaco2010@ymail.com

[MANDALE HEALTHCARE] / Iraq

Kurdistan region, Sulimanya city, end of Goran street, Salim Bag Building, floor 4, Flat No.1
Tel : (+09)6477-0146-6409
E-mail : yankialawi@yahoo.com

[IMPLAMEDICA] / Lebanon

Implamedica est Centre St. Georgers, Adonis, 4th floor, Lebanon
Tel : (+961)7085-5249; (+961)7001-5532
E-mail : info@megagenlebanon.com

[Dental Guru] / Russia

Bld 43/2, Pokrovka Str. Moscow, 105062, Russia
Tel : (+7)92-6526-2697
E-mail : implantguru@gmail.com

[SAMD Company] / Saudi Arabia

P.O. Box : 381182 Riyadh. 11345, Kingdom of Saudi Arabia
Tel : (+96)6-1431-1188
E-mail : samdcomp@gmail.com

[MegaGen Turkiye] / Turkey

Gulbahar Mah. Buyukdere Cad. No:99 D:7, Mecidiyekoy, Istanbul Turkey
Tel : (+90)21-2211-3932
E-mail : info@megagen.com.tr

[Ningbo Megagen China] / China

No.456 Tonghui road, Jiangbei Inverstment&Pioneering (Park C), Ningbo
Tel : (+86)574-2770-9928
E-mail : megagen@hotmail.com

[MegaGen Hong Kong Ltd] / Hong Kong

Room 604D, InnoCentre 72 Tat Chee Avenue, Kowloon Tong Kowloon, Hong Kong
Tel : (+852)2866-0199
E-mail : megagenhk@gmail.com

[SREE Implantology Solutions India Private limited] / India

D.No.48-12-11B, F.No.201, CBR Residency, Eluru Road, Gunadala, BesideTelephoneExchange,
Vijayawada-520005, AndhraPradesh, INDIA
Tel : (+91)99-6623-8456
E-mail : info@sreeimplants.com

[Dental Solutions & Services Pte Ltd] / Singapore

Blk 28 kallang place #05-16 Singapore 339158 / www.dentalsolutions.sg
Tel : (+65)9147-4633
E-mail : andy.poh@dentalsolutions.sg

[Sunriser Medical] / Taiwan

5 SEC., CHUNG-HSIAO E.RD NANGANG DISTRICT., TAIPEI, TAIWAN 115
Tel : (+88)6-2-27881335
E-mail : sunrise.medical@msa.hinet.net

[Dental-Siam Enterprise Co., Ltd] / Thailand

54 Soi Phanit-Anan, Sukhumvit 71 Road., Klongton Nua, Wattana, BKK 10110 Thailand
Tel : (+66)2713-3355 Ext. 300
E-mail : Praphaporn@dental-siam.co.th