

Rescue[®]

Internal

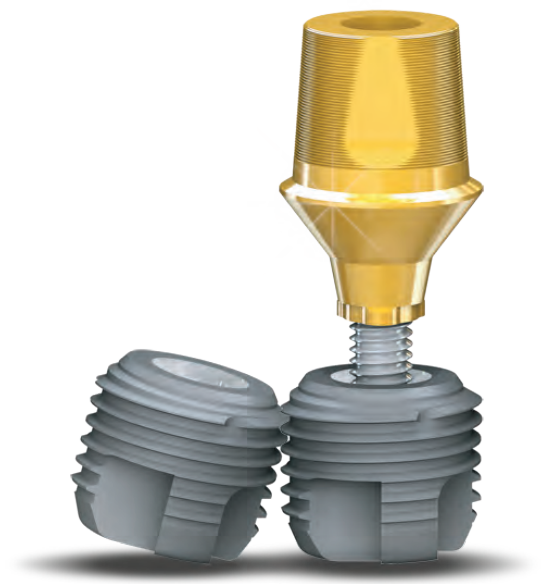

Rescue[®] Internal

Super Wide & Short The Most Effective Implant System for Molar Reconstruction!

Submerged Internal Trip Connection

- ▶ Unlike other wide diameter fixtures which have experienced severe bone loss, our specially engineered design with platform switching maintains crestal bone.
- ▶ Restoration of molar sites can be achieved with Rescue implants, despite minimal vertical height and inferior osseous tissue sites.
- ▶ Extraction sockets can be restored with Rescue fixtures.

Design The 0,8 degree pitched thread provides maximum contact for effective osseointegration. Because of the buttress thread design, it can withstand strong masticatory forces. The four cutting edges and guided bottom ensure maximum initial stability.

Surface Our Super RBM Surface Treatment produces a favorable surface topography that has been proven through extensive systematic testing. MegaGen's Super RBM Surface shortens loading time and provides favorable results in any bone quality.

Feature Internal Trip Connection - MegaGen's Trip anti-rotation structure will not deform until 420N of insertion torque, allowing for extremely stable initial fixation. The 11° Internal Connection Wall, which is a proven concept of Morse Taper & Conical Seal, effectively allows for extremely high occlusal and lateral forces. Initial stability upon placement is provided.

Surgery Super wide fixtures can be placed with a two step drilling procedure consisting of a Trephine drill and a Pilot drill, (using the drill stop in the trephine drill). The Rescue surgical kit can be used for internal and external fixtures as an economical solution.

Prosthetics The Rescue Internal system provides various Internal Trip Connection Abutments (UCLA Gold, EZ Post, Milling abutment, Solid abutment system) that have $\varnothing 6,0$, $8,0$, $10,0$ mm wide healing abutments & $\varnothing 6,0$, $7,0$, $8,0$ mm profile abutment diameters. This conveniently provides esthetic and functional prosthetic options.

Packaging

No-Mount Type : Rescue Internal Fixture and Cover Screw

D1	D2	L (mm)
$\varnothing 6.0$	$\varnothing 4.5$	5.0
$\varnothing 6.5$	$\varnothing 5.0$	6.0
$\varnothing 7.0$	$\varnothing 5.0$	7.0
$\varnothing 7.5$	$\varnothing 5.0$	8.5
$\varnothing 7.5$	$\varnothing 5.5$	10.0
$\varnothing 7.5$	$\varnothing 5.5$	11.5
$\varnothing 8.0$	$\varnothing 6.0$	13.0

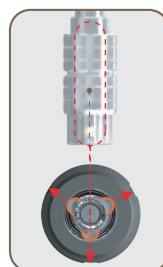

▶ Trip Indicating Grooves

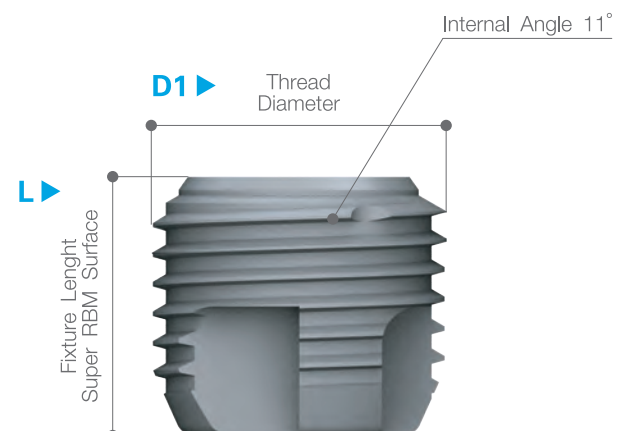
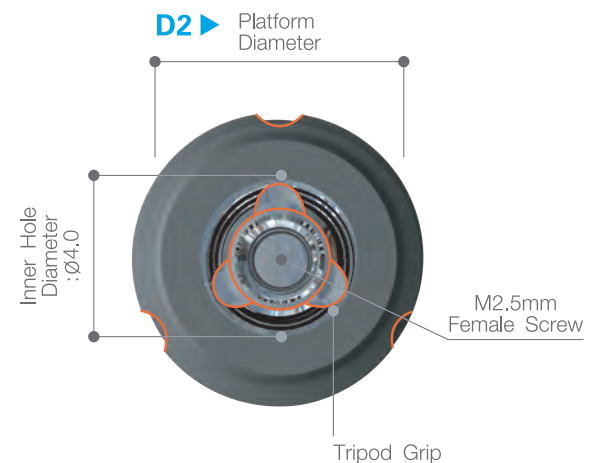

Rescue[®] Internal / 3 Step Surgical Procedure & Instruments

Dental Implant Specialty Company, **MegaGen!**

Ref : Reference Code

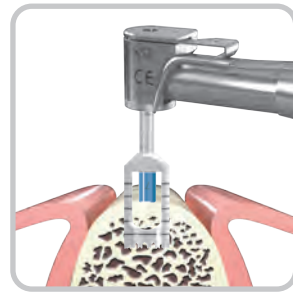

STEP 1: Trepine Drilling with Stopper¹

In order to create the osteotomy, follow drilling sequence according to fixture diameter.
For safe trephine drilling, rotate drill in counter clockwise direction until saw part of trephine bur engages crest of bone. Then proceed drilling in clockwise direction.

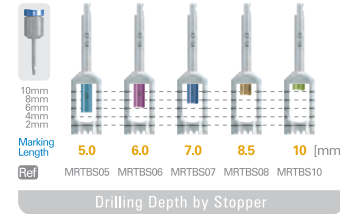

STEP 2: Pilot Drilling²

In accordance with drilling sequence, extend the osteotomy using the pilot drill.

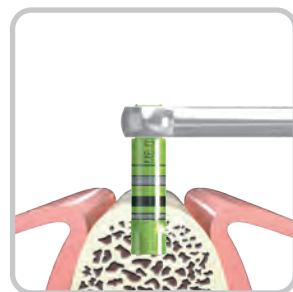

STEP 3: Tapping³

In dense bone situations, pre-tapping may be required prior to placement of fixture.



STEP 4: Fixture Placement⁴

Use mount-free handpiece connector to place fixture.
If necessary, complete placement by using the ratchet wrench.
To easily verify trip direction in fixture, notch indicators are provided at the coronal portion of the implant.

For 6.0 & 6.5 Diameter Fixtures	For 7.0 & 7.5 Diameter Fixtures	For 8.0 Diameter Fixture
<p>Ref MRTB4010</p> <p>Inner Dia.: $\varnothing 4.0$ Outer Dia.: $\varnothing 5.0$</p>	<p>Ref MRTB5010</p> <p>Inner Dia.: $\varnothing 5.0$ Outer Dia.: $\varnothing 6.0$</p>	<p>Ref MRTB6010</p> <p>Inner Dia.: $\varnothing 6.0$ Outer Dia.: $\varnothing 7.0$</p>
<p>Ref MRPD540</p> <p>$\varnothing 5.4$ $\varnothing 5.9$</p>	<p>Ref MRPD640</p> <p>$\varnothing 6.4$ $\varnothing 6.9$</p>	<p>Ref MRPD740</p> <p>$\varnothing 7.4$</p>
<p>Ref MTPR6001 MTPH6001</p> <p>$\varnothing 6.0$ $\varnothing 6.0$</p>	<p>Ref MTPR6501 MTPH6501</p> <p>$\varnothing 6.5$ $\varnothing 6.5$</p>	<p>Ref MTPR7001 MTPH7001</p> <p>$\varnothing 7.0$ $\varnothing 7.0$</p>
<p>Ref MTPR7501 MTPH7501</p> <p>$\varnothing 7.5$ $\varnothing 7.5$</p>	<p>Ref MTPR8001 MTPH8001</p> <p>$\varnothing 8.0$ $\varnothing 8.0$</p>	<p>Ref MTPR8001 MTPH8001</p> <p>$\varnothing 8.0$ $\varnothing 8.0$</p>
<p>Ref $\varnothing 6.0$ $\varnothing 6.5$</p>	<p>Ref $\varnothing 7.0$ $\varnothing 7.5$</p>	<p>Ref $\varnothing 8.0$</p>

OPEN END WRENCH
Ref MOW400

RATCHET WRENCH
Ref MRW040S

RESCUE IMPLANT SYSTEM

5mm 6mm 7mm 8.5mm 10.0mm

1 FIXTURE LENGTH

2 PILOT DRILL

3 TAP (HANDPIECE) TAP (RATCHET)

4 H.P. CON. RATCHET EXT. OPTION

5 DRILL EXT. EXT. PLUS DIRECTION INDICATOR HAND DRIVER

INTERNAL EXTERNAL

► SGI Rescue Noble Kit

RESCUE INTERNAL

4 H.P Connector Ratchet Extension

Ref MRHC100 MRHC200

Ref MRIR100S MRIR100L

5 Drill Extension Direction Indicator Hand Driver

Ref MDE150 MDI5060 MHD120L

Usage of Ext. Plus (Ratchet Extender)

Ref MRE400S

Extension Plus : Extend the length of Ratchet Extension





► Ratchet Extension [Ext/Int]









Rescue® Internal / Abutments



Dental Implant Specialty Company, **MegaGen!**

Ref : Reference Code ● Non-Trip Type ▲ Trip Type CH : Cuff Height PD : Profile Diameter PH : Post Height

Cover Screw	Healing Abutment
<p>1.2 Hex ●</p>  <p>Ref ARSIC100</p>	<p>PD: Ø6.0 CH: 2/3/4/5mm</p>  <p>ARSIH602 ARSIH603 ARSIH604 ARSIH605</p>
	<p>PD: Ø8.0 CH: 2/3/4/5mm</p> <p>1.2 Hex ●</p>  <p>ARSIH802 ARSIH803 ARSIH804 ARSIH805</p>
	<p>PD: Ø10.0 CH: 2/3/4/5mm</p> <p>1.2 Hex ●</p>  <p>ARSIH1002 ARSIH1003 ARSIH1004 ARSIH1005</p>

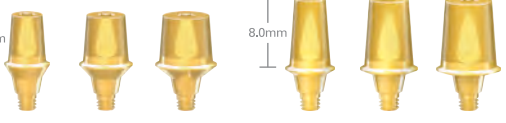
Impression Coping [Transfer Type]	Abutment Screw	Gold Abutment
 <p>ARII100</p>	<p>1.2 Hex ●</p>  <p>Short Long</p> <p>ARAS250 for 5mm Fixture ARAS250L for 6~13mm Fixture</p> <p>ARGA200T</p>	
	<p>Temporary Abutment</p>  <p>ARIT100T ARIT200T</p>	 <p>ARGA100T</p>
<p>Impression Coping [Pick-up Type]</p>  <p>ARII400T ARII200T ARIG100</p>	<p>Lab Analog</p>  <p>ARLA600</p>	

EZ Post [Post Height = 6.0mm]
<p>CH: 1/2/3/4 mm</p> <p>1.2 Hex ●</p>  <p>PD: Ø6.0 Ø7.0 Ø8.0</p> <p>ARSIPN601T ARSIPN701T ARSIPN801T ARSIP601T ARSIP701T ARSIP801T ARSIPN602T ARSIPN702T ARSIPN802T ARSIP602T ARSIP702T ARSIP802T ARSIPN603T ARSIPN703T ARSIPN803T ARSIP603T ARSIP703T ARSIP803T ARSIPN604T ARSIPN704T ARSIPN804T ARSIP604T ARSIP704T ARSIP804T</p>
<p>EZ Post [Post Height = 8.0mm]</p> <p>CH: 1/2/3/4 mm</p> <p>1.2 Hex ●</p>  <p>PD: Ø6.0 Ø7.0 Ø8.0</p> <p>ARSIPN681T ARSIPN781T ARSIPN881T ARSIP681T ARSIP781T ARSIP881T ARSIPN682T ARSIPN782T ARSIPN882T ARSIP682T ARSIP782T ARSIP882T ARSIPN683T ARSIPN783T ARSIPN883T ARSIP683T ARSIP783T ARSIP883T ARSIPN684T ARSIPN784T ARSIPN884T ARSIP684T ARSIP784T ARSIP884T</p>
<p>Solid Abutment</p> <p>CH: 1/2/3/4 mm</p> <p>1.2 Hex ● 2.5 Hex ●</p>  <p>PD: Ø6.0 Ø7.0 Ø8.0</p> <p>ARSIS601 ARSIS701 ARSIS801 ARSIS681 ARSIS781 ARSIS881 ARSIS602 ARSIS702 ARSIS802 ARSIS682 ARSIS782 ARSIS882 ARSIS603 ARSIS703 ARSIS803 ARSIS683 ARSIS783 ARSIS883 ARSIS604 ARSIS704 ARSIS804 ARSIS684 ARSIS784 ARSIS884</p>

Comport Cap	Snap Impression Coping	Lab Analog
 <p>PD: Ø6.0 Ø7.0 Ø8.0</p> <p>ARIC06 ARIC07 ARIC08</p>	<p>10.0mm</p>  <p>PD: Ø6.0 Ø7.0 Ø8.0</p> <p>ARIIC06 ARIIC07 ARIIC08</p>	 <p>PD: Ø6.0 Ø7.0 Ø8.0</p> <p>ARIPL660 ARIPL760 ARIPL860 ARIPL680 ARIPL780 ARIPL880</p>



■ Rescue Internal Fixture

Fixture		
Ref. Code	Description	Page
RSWIR6005C	∅6.0 x L5.0mm / MF	p1
RSWIR6006C	∅6.0 x L6.0mm / MF	
RSWIR6007C	∅6.0 x L7.0mm / MF	
RSWIR6008C	∅6.0 x L8.5mm / MF	
RSWIR6010C	∅6.0 x L10.0mm / MF	
RSWIR6011C	∅6.0 x L11.5mm / MF	
RSWIR6013C	∅6.0 x L13.0mm / MF	
RSWIR6505C	∅6.5 x L5.0mm / MF	p1
RSWIR6506C	∅6.5 x L6.0mm / MF	
RSWIR6507C	∅6.5 x L7.0mm / MF	
RSWIR6508C	∅6.5 x L8.5mm / MF	
RSWIR6510C	∅6.5 x L10.0mm / MF	
RSWIR6511C	∅6.5 x L11.5mm / MF	
RSWIR6513C	∅6.5 x L13.0mm / MF	
RSWIR7005C	∅7.0 x L5.0mm / MF	p1
RSWIR7006C	∅7.0 x L6.0mm / MF	
RSWIR7007C	∅7.0 x L7.0mm / MF	
RSWIR7008C	∅7.0 x L8.5mm / MF	
RSWIR7010C	∅7.0 x L10.0mm / MF	
RSWIR7011C	∅7.0 x L11.5mm / MF	
RSWIR7013C	∅7.0 x L13.0mm / MF	
RSWIR7505C	∅7.5 x L5.0mm / MF	p1
RSWIR7506C	∅7.5 x L6.0mm / MF	
RSWIR7507C	∅7.5 x L7.0mm / MF	
RSWIR7508C	∅7.5 x L8.5mm / MF	
RSWIR7510C	∅7.5 x L10.0mm / MF	
RSWIR7511C	∅7.5 x L11.5mm / MF	
RSWIR7513C	∅7.5 x L13.0mm / MF	
RSWIR8005C	∅8.0 x L5.0mm / MF	p1
RSWIR8006C	∅8.0 x L6.0mm / MF	
RSWIR8007C	∅8.0 x L7.0mm / MF	
RSWIR8008C	∅8.0 x L8.5mm / MF	
RSWIR8010C	∅8.0 x L10.0mm / MF	
RSWIR8011C	∅8.0 x L11.5mm / MF	
RSWIR8013C	∅8.0 x L13.0mm / MF	

■ Instrument

Instrument		
Ref. Code	Description	Page
MRTB4010	Trephine Bur / In ∅4.0 / Out ∅5.0mm	p2
MRTB5010	Trephine Bur / In ∅5.0 / Out ∅6.0mm	
MRTB6010	Trephine Bur / In ∅6.0 / Out ∅7.0mm	
MRTBS05	Trephine Stopper / 5.0mm	p2
MRTBS06	Trephine Stopper / 6.0mm	
MRTBS07	Trephine Stopper / 7.0mm	
MRTBS08	Trephine Stopper / 8.5mm	
MRTBS10	Trephine Stopper / 10.0mm	p2
MRPD540	Pilot Drill / ∅5.4mm	
MRPD590	Pilot Drill / ∅5.9mm	
MRPD640	Pilot Drill / ∅6.4mm	
MRPD690	Pilot Drill / ∅6.9mm	
MRPD740	Pilot Drill / ∅7.4mm	
MTPR600I	Tap / Ratchet / ∅6.0mm	
MTPR650I	Tap / Ratchet / ∅6.5mm	
MTPR700I	Tap / Ratchet / ∅7.0mm	
MTPR750I	Tap / Ratchet / ∅7.5mm	
MTPR800I	Tap / Ratchet / ∅8.0mm	
MTPH600I	Tap / Handpiece / ∅6.0mm	p2
MTPH650I	Tap / Handpiece / ∅6.5mm	
MTPH700I	Tap / Handpiece / ∅7.0mm	
MTPH750I	Tap / Handpiece / ∅7.5mm	
MTPH800I	Tap / Handpiece / ∅8.0mm	p2
MRHC100	Handpiece Connector / Short	
MRHC200	Handpiece Connector / Long	p2
MRIR100S	Ratchet Extension / Short	
MRIR100L	Ratchet Extension / Long	p2
MHD120L	Hand Driver 1.2 Hex / Long	
MDI5060	Direction Indicator / ∅5.0 / ∅6.0mm	
MRE400S	Ratchet Extension Plus	
MRW040S	Ratchet Wrench	
MOW400	Open Wrench	



■ Abutment

Cover Screw

Ref. Code	Description	Page
ARSIC100	Cover Screw	p3

Healing Abutment

ARSIH602	PD=Ø6.0 / CH=2mm	p3
ARSIH603	PD=Ø6.0 / CH=3mm	
ARSIH604	PD=Ø6.0 / CH=4mm	
ARSIH605	PD=Ø6.0 / CH=5mm	
ARSIH802	PD=Ø8.0 / CH=2mm	p3
ARSIH803	PD=Ø8.0 / CH=3mm	
ARSIH804	PD=Ø8.0 / CH=4mm	
ARSIH805	PD=Ø8.0 / CH=5mm	
ARSIH1002	PD=Ø10.0 / CH=2mm	p3
ARSIH1003	PD=Ø10.0 / CH=3mm	
ARSIH1004	PD=Ø10.0 / CH=4mm	
ARSIH1005	PD=Ø10.0 / CH=5mm	

Impression Coping

ARII100	Impression Coping / Transfer / Non-Trip	p3
ARII300T	Impression Coping / Transfer / Trip	
ARII200T	Impression Coping / Pick up / Trip	
ARII400T	Impression Coping / Pick up / Non-Trip	
ARIG100	Guide Pin 10mm	p3
ARIG200	Guide Pin 15mm	
ARIIC06	Snap Impression Coping / PD=Ø6.0mm	p3
ARIIC07	Snap Impression Coping / PD=Ø7.0mm	
ARIIC08	Snap Impression Coping / PD=Ø8.0mm	

Lab Analog

ARLA600	Fixture level Lab Analog	p3
---------	--------------------------	----

Temporary Abutment

ARIT100T	Non-Trip	p3
ARIT200T	Trip	

Gold Abutment

ARGA100T	Non-Trip	p3
ARGA200T	Trip	

Abutment Screw

ARAS250	For Short Rescue / 5mm	p3
ARAS250L	For Regular Rescue / 6~13mm	

Solid Abutment

ARSIS601	PD Ø6.0 x PH 6.0 x CH 1.0mm	p3
ARSIS602	PD Ø6.0 x PH 6.0 x CH 2.0mm	
ARSIS603	PD Ø6.0 x PH 6.0 x CH 3.0mm	
ARSIS604	PD Ø6.0 x PH 6.0 x CH 4.0mm	
ARSIS701	PD Ø7.0 x PH 6.0 x CH 1.0mm	p3
ARSIS702	PD Ø7.0 x PH 6.0 x CH 2.0mm	
ARSIS703	PD Ø7.0 x PH 6.0 x CH 3.0mm	
ARSIS704	PD Ø7.0 x PH 6.0 x CH 4.0mm	

Ref. Code	Description	Page
ARSIS801	PD Ø8.0 x PH 6.0 x CH 1.0mm	p3
ARSIS802	PD Ø8.0 x PH 6.0 x CH 2.0mm	
ARSIS803	PD Ø8.0 x PH 6.0 x CH 3.0mm	
ARSIS804	PD Ø8.0 x PH 6.0 x CH 4.0mm	
ARSIS681	PD Ø6.0 x PH 8.0 x CH 1.0mm	p3
ARSIS682	PD Ø6.0 x PH 8.0 x CH 2.0mm	
ARSIS683	PD Ø6.0 x PH 8.0 x CH 3.0mm	
ARSIS684	PD Ø6.0 x PH 8.0 x CH 4.0mm	
ARSIS781	PD Ø7.0 x PH 8.0 x CH 1.0mm	p3
ARSIS782	PD Ø7.0 x PH 8.0 x CH 2.0mm	
ARSIS783	PD Ø7.0 x PH 8.0 x CH 3.0mm	
ARSIS784	PD Ø7.0 x PH 8.0 x CH 4.0mm	
ARSIS881	PD Ø8.0 x PH 8.0 x CH 1.0mm	p3
ARSIS882	PD Ø8.0 x PH 8.0 x CH 2.0mm	
ARSIS883	PD Ø8.0 x PH 8.0 x CH 3.0mm	
ARSIS884	PD Ø8.0 x PH 8.0 x CH 4.0mm	
Comfort Cap		
ARIC06	Comfort Cap Ø6.0	p3
ARIC07	Comfort Cap Ø7.0	
ARIC08	Comfort Cap Ø8.0	
EZ Post		
ARSIPN601T	PD Ø6.0 x PH 6.0 x CH 1.0mm / Non-Trip	p3
ARSIPN602T	PD Ø6.0 x PH 6.0 x CH 2.0mm / Non-Trip	
ARSIPN603T	PD Ø6.0 x PH 6.0 x CH 3.0mm / Non-Trip	
ARSIPN604T	PD Ø6.0 x PH 6.0 x CH 4.0mm / Non-Trip	
ARSIPN681T	PD Ø6.0 x PH 8.0 x CH 1.0mm / Non-Trip	p3
ARSIPN682T	PD Ø6.0 x PH 8.0 x CH 2.0mm / Non-Trip	
ARSIPN683T	PD Ø6.0 x PH 8.0 x CH 3.0mm / Non-Trip	
ARSIPN684T	PD Ø6.0 x PH 8.0 x CH 4.0mm / Non-Trip	
ARSIPN701T	PD Ø7.0 x PH 6.0 x CH 1.0mm / Non-Trip	p3
ARSIPN702T	PD Ø7.0 x PH 6.0 x CH 2.0mm / Non-Trip	
ARSIPN703T	PD Ø7.0 x PH 6.0 x CH 3.0mm / Non-Trip	
ARSIPN704T	PD Ø7.0 x PH 6.0 x CH 4.0mm / Non-Trip	
ARSIPN781T	PD Ø7.0 x PH 8.0 x CH 1.0mm / Non-Trip	p3
ARSIPN782T	PD Ø7.0 x PH 8.0 x CH 2.0mm / Non-Trip	
ARSIPN783T	PD Ø7.0 x PH 8.0 x CH 3.0mm / Non-Trip	
ARSIPN784T	PD Ø7.0 x PH 8.0 x CH 4.0mm / Non-Trip	
ARSIPN801T	PD Ø8.0 x PH 6.0 x CH 1.0mm / Non-Trip	p3
ARSIPN802T	PD Ø8.0 x PH 6.0 x CH 2.0mm / Non-Trip	
ARSIPN803T	PD Ø8.0 x PH 6.0 x CH 3.0mm / Non-Trip	
ARSIPN804T	PD Ø8.0 x PH 6.0 x CH 4.0mm / Non-Trip	
ARSIPN881T	PD Ø8.0 x PH 8.0 x CH 1.0mm / Non-Trip	p3
ARSIPN882T	PD Ø8.0 x PH 8.0 x CH 2.0mm / Non-Trip	
ARSIPN883T	PD Ø8.0 x PH 8.0 x CH 3.0mm / Non-Trip	
ARSIPN884T	PD Ø8.0 x PH 8.0 x CH 4.0mm / Non-Trip	
ARSIP601T	PD Ø6.0 x PH 6.0 x CH 1.0mm / Trip	p3
ARSIP602T	PD Ø6.0 x PH 6.0 x CH 2.0mm / Trip	
ARSIP603T	PD Ø6.0 x PH 6.0 x CH 3.0mm / Trip	
ARSIP604T	PD Ø6.0 x PH 6.0 x CH 4.0mm / Trip	



Rescue[®] Internal

Dental Implant Specialty Company, **MegaGen!**

CH : Cuff Height PD : Profile Diameter PH : Post Height

Ref. Code	Description	Page
ARSIP681T	PD Ø6.0 x PH 8.0 x CH 1.0mm / Trip	p3
ARSIP682T	PD Ø6.0 x PH 8.0 x CH 2.0mm / Trip	
ARSIP683T	PD Ø6.0 x PH 8.0 x CH 3.0mm / Trip	
ARSIP684T	PD Ø6.0 x PH 8.0 x CH 4.0mm / Trip	
ARSIP701T	PD Ø7.0 x PH 6.0 x CH 1.0mm / Trip	p3
ARSIP702T	PD Ø7.0 x PH 6.0 x CH 2.0mm / Trip	
ARSIP703T	PD Ø7.0 x PH 6.0 x CH 3.0mm / Trip	
ARSIP704T	PD Ø7.0 x PH 6.0 x CH 4.0mm / Trip	
ARSIP781T	PD Ø7.0 x PH 8.0 x CH 1.0mm / Trip	p3
ARSIP782T	PD Ø7.0 x PH 8.0 x CH 2.0mm / Trip	
ARSIP783T	PD Ø7.0 x PH 8.0 x CH 3.0mm / Trip	
ARSIP784T	PD Ø7.0 x PH 8.0 x CH 4.0mm / Trip	
ARSIP801T	PD Ø8.0 x PH 6.0 x CH 1.0mm / Trip	p3
ARSIP802T	PD Ø8.0 x PH 6.0 x CH 2.0mm / Trip	
ARSIP803T	PD Ø8.0 x PH 6.0 x CH 3.0mm / Trip	
ARSIP804T	PD Ø8.0 x PH 6.0 x CH 4.0mm / Trip	
ARSIP881T	PD Ø8.0 x PH 8.0 x CH 1.0mm / Trip	p3
ARSIP882T	PD Ø8.0 x PH 8.0 x CH 2.0mm / Trip	
ARSIP883T	PD Ø8.0 x PH 8.0 x CH 3.0mm / Trip	
ARSIP884T	PD Ø8.0 x PH 8.0 x CH 4.0mm / Trip	
Solid & Post Lab Analog		
ARIPL660	PD=Ø6.0 / PH=6mm	p3
ARIPL680	PD=Ø6.0 / PH=8mm	
ARIPL760	PD=Ø7.0 / PH=6mm	p3
ARIPL780	PD=Ø7.0 / PH=8mm	
ARIPL860	PD=Ø8.0 / PH=6mm	p3
ARIPL880	PD=Ø8.0 / PH=8mm	





Customer Service

[HEAD OFFICE] www.imegagen.com

MEGAGEN IMPLANT CO.,LTD

472, HANJANGGUN-RO, JAIN-MYUN, GYEONGSAN, GYEONGBUK, KOREA, 712-852
5F MegaGen Tower, 607 Seolleung-ro, Gangnam-gu, Seoul, Korea
Tel: 82-53-857-5770
Fax: 82-53-857-5432
E-mail: sales@imegagen.com

[Megagen USA INC.] / USA

440 Sylvan Ave. Suite 200 Englewood Cliffs, NJ 07632, USA
Tel : (+1)866-277-5662
E-mail : info@megagenus.com

[ISG Dental GmbH] / Austria

Wiegelestrasse 10, 1230 Vienna, AUSTRIA
Tel : (+43)1869-3220
E-mail : r.schultschik@isg-gmbh.at

[Implant2dentist] / Denmark

Tandlaegerne i kogade I/S Kogade 4 6270 Toender Denmark
Tel : (+45)7010-8700, (+45)2835-5459
E-mail : mikkelro@implant2dentist.dk

[Megagen Hellas LTD] / Greece

19th G. Papandreou Str., 15773 Zografou, Athens, GREECE
Tel : (+30)21-0748-5533, (+30)21-0748-5544
E-mail : george.kouratiadis@dentomedica.gr

[MegaGen Italia S.R.L.] / Italy

VIA MAZZINI 43/b - 22030 Pusiano (Co), ITALY
Tel : (+39)34-8085-5432
E-mail : info@megagenitalia.it

[UAB "ImplaMedica"] / Lithuania

Kalvariju 272, LT-08316 Vilnius, Republic of Lithuania
Tel : (+37)5219-5971
E-mail : info@implamedica.lt

[MegaGen Benelux b.v.] / Netherlands

Prof. Cobbenhagenlaan 99, 5037 DB Tilburg, The Netherlands
Tel : (+31)8-8848-4100, (+31)6-2000-9582
E-mail : info@megagenbenelux.nl

[Megagen Portugal Lda] / Portugal

Rua dos Açores 67, 4430-643 Vila Nova de Gaia, Portugal
Tel : (+351)2-2488-4026
E-mail : geral@megagen.pt

[MEGAGEN DENTAL IMPLANT] / Romania

STR. Mamulari nr.4, BIC2, sc.2, ap.37 sec.3, Bucuresti
Tel : (+40)3-1418-1238
E-mail : ciprian.amarandei@megagen.ro

[Createch Medical SL] / Spain

Pol. Kurutz Gain, Pab 3 20850 Mendaro (Guipúzcoa), Spain
Tel : (+34)9-4375-7172
E-mail : createch@createchmedical.com

[Orexa Dental AB] / Sweden

Berggrensgatan 8, 412 73 Gothenburg, Sweden
Tel: (+46)709-208000
E-mail : info@orexa.se

[Megagen Implants UK] / United Kingdom

Hemel Business Centre Westside, London Road Apsley Hemel Hempstead Herts HP3 9TD UK
Tel : (+44)14-4284-0326
E-mail : dima.corduneanu@megagen.co.uk

[Abtin Pezeshk Abzar Co.] / Iran

Unit 12, 3th Floor, building pezashkan sabz 2 (No8), Imam zadeh Alley, Opposite Dowlat St,Shariati,Tehran-Iran
Tel : (+98)21-26600568-70 / Fax : (+98)21-22612438
E-mail : apaco2010@ymail.com

[MANDALE HEALTHCARE] / Iraq

Kurdistan region, Sulimanya city, end of Goran street, Salim Bag Building, floor 4, Flat No.1
Tel : (+09)6477-0146-6409
E-mail : yankialawi@yahoo.com

[IMPLAMEDICA] / Lebanon

Implamedica est Centre St. Georgers, Adonis, 4th floor, Lebanon
Tel : (+961)7085-5249; (+961)7001-5532
E-mail : info@megagenlebanon.com

[Dental Guru] / Russia

Bld 43/2, Pokrovka Str. Moscow, 105062, Russia
Tel : (+7)92-6526-2697
E-mail : implantguru@gmail.com

[SAMD Company] / Saudi Arabia

P.O. Box : 381182 Riyadh. 11345, Kingdom of Saudi Arabia
Tel : (+96)6-1431-1188
E-mail : samdcomp@gmail.com

[MegaGen Turkiye] / Turkey

Gulbahar Mah. Buyukdere Cad. No:99 D:7, Mecidiyekoy, Istanbul Turkey
Tel : (+90)21-2211-3932
E-mail : info@megagen.com.tr

[Ningbo Megagen China] / China

No.456 Tonghui road, Jiangbei Inverstment&Pioneering (Park C), Ningbo
Tel : (+86)574-2770-9928
E-mail : megagen@hotmail.com

[MegaGen Hong Kong Ltd] / Hong Kong

Room 604D, InnoCentre 72 Tat Chee Avenue, Kowloon Tong Kowloon, Hong Kong
Tel : (+852)2866-0199
E-mail : megagenhk@gmail.com

[SREE Implantology Solutions India Private limited] / India

D.No.48-12-11B, F.No.201, CBR Residency, Eluru Road, Gunadala, BesideTelephoneExchange,
Vijayawada-520005, AndhraPradesh, INDIA
Tel : (+91)99-6623-8456
E-mail : info@sreeimplants.com

[Dental Solutions & Services Pte Ltd] / Singapore

Blk 28 kallang place #05-16 Singapore 339158 / www.dentalsolutions.sg
Tel : (+65)9147-4633
E-mail : andy.poh@dentalsolutions.sg

[Sunriser Medical] / Taiwan

5 SEC., CHUNG-HSIAO E.RD NANGANG DISTRICT., TAIPEI, TAIWAN 115
Tel : (+88)6-2-27881335
E-mail : sunrise.medical@msa.hinet.net

[Dental-Siam Enterprise Co., Ltd] / Thailand

54 Soi Phanit-Anan, Sukhumvit 71 Road., Klongton Nua, Wattana, BKK 10110 Thailand
Tel : (+66)2713-3355 Ext. 300
E-mail : Praphaporn@dental-siam.co.th

