

IntermezzoTM

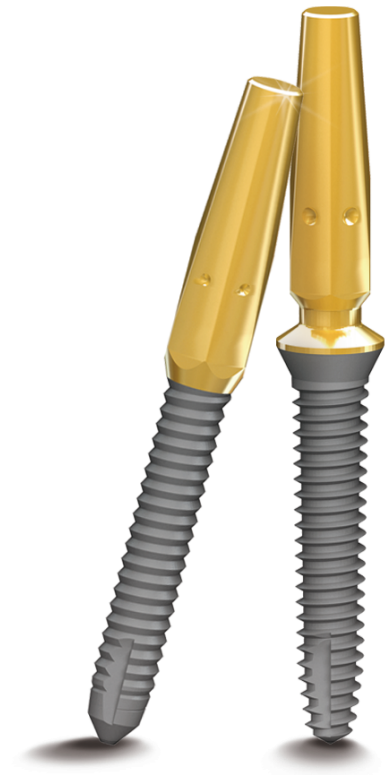

IntermezzoTM

Temporary and Permanent

One-piece Implant System, Super RBM Surface, Bendable Neck Design

- ▶ Success at your fingertips, Permanent or temporary implants,
To provide temporary prosthesis after placing standard implants, Can be used as permanent implant in narrow part of proximal bone,

Design Innovative design that supersedes previous temporary implant limitations. Sizes include $\varnothing 1,6$, $2,0$, $2,5$, $3,1$ mm with various thread diameters and lengths, According to diameter, you can achieve proper fixation and osseointegration by applying 2 types of thread designs (temporary or permanent),

Surface Our Super RBM Surface Treatment produces a favorable surface topography that has been proven through extensive systematic testing, MegaGen's Super RBM Surface will shorten loading time and provide favorable results in any bone quality,

Feature Cortical block testing was applied for the $\varnothing 2,5$, $3,1$ mm fixtures and was proven to provide initial stability, By design, the Intermezzo can be used in extraction sockets and immediate placement, A bending neck up until 15° can provide favorable results in the anterior mandible, as well as maxillary lateral incisors and their restorations, The 9mm post height facilitates proper final prosthetic size in any situation, It can easily be altered for shorter abutment heights,

Surgery Intermezzo minimizes the drilling sequence with 1 step insertion, After drilling, according to bone type, fixation can be provided by either handpiece connector or hand driver,

Prosthetics Analogs and snap impression copings are conveniently provided for every fixture diameter that we manufacture,

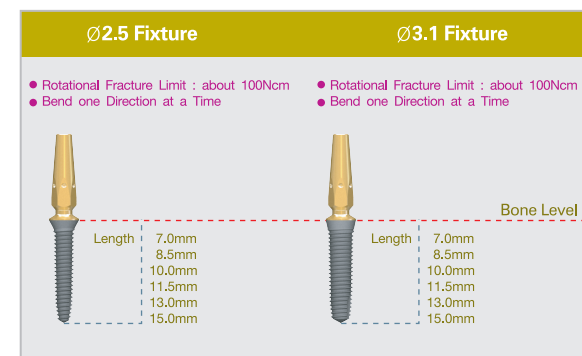
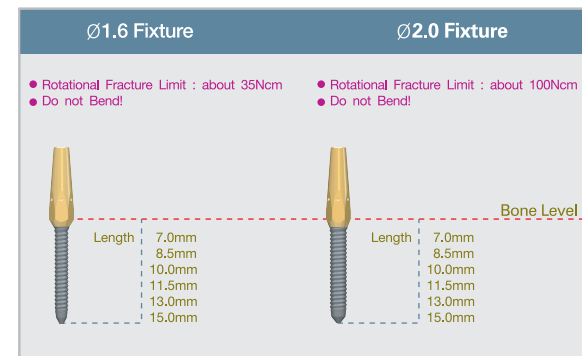
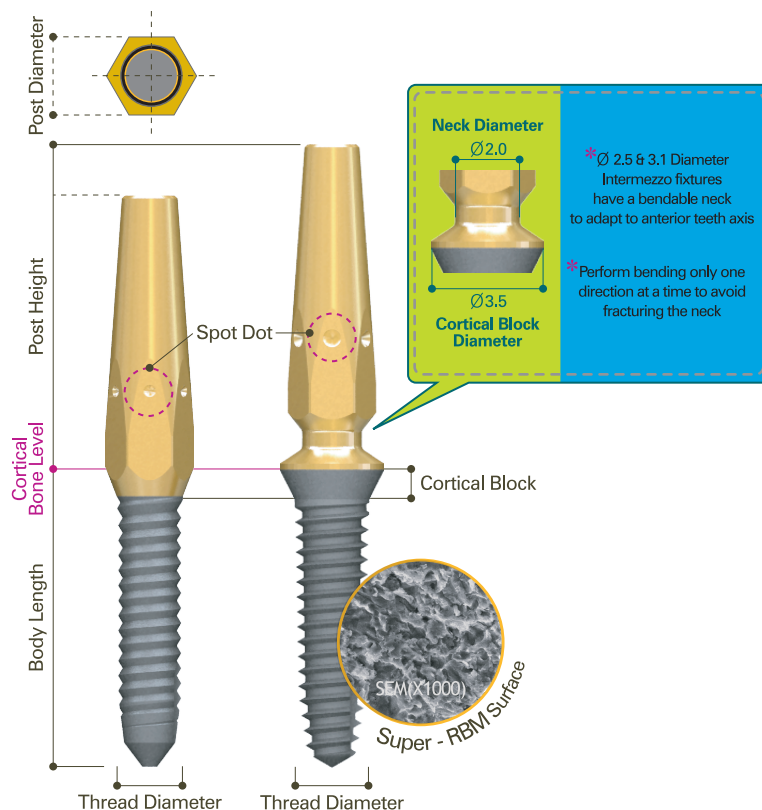

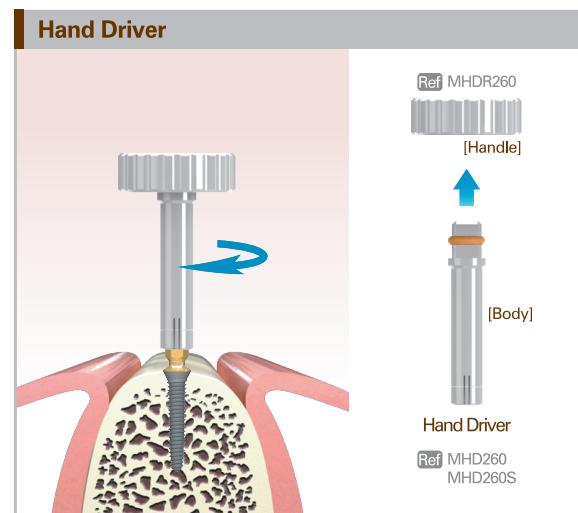
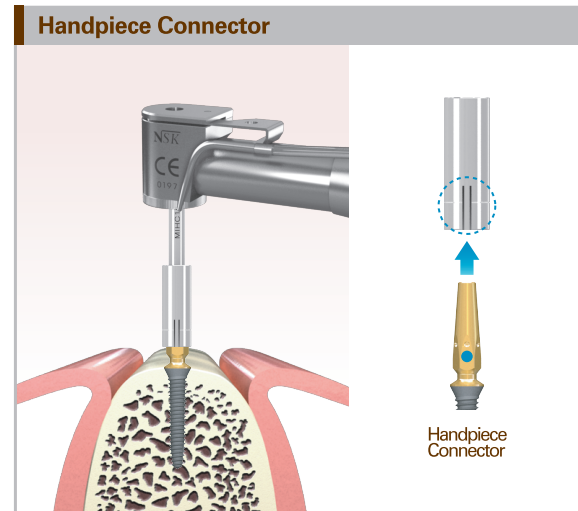
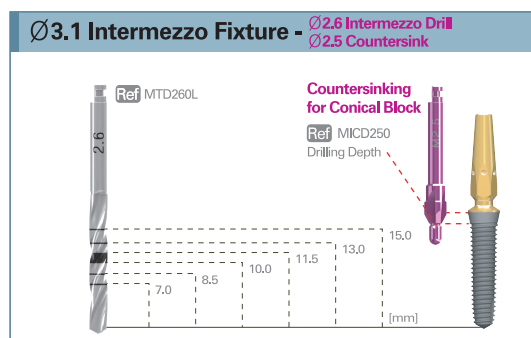
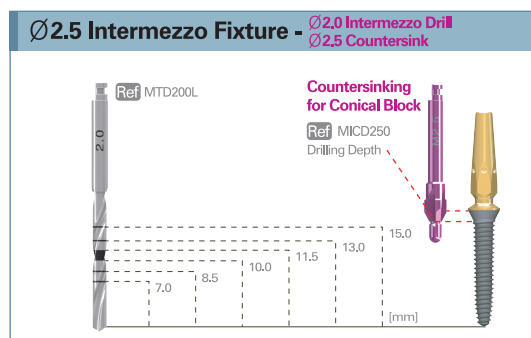
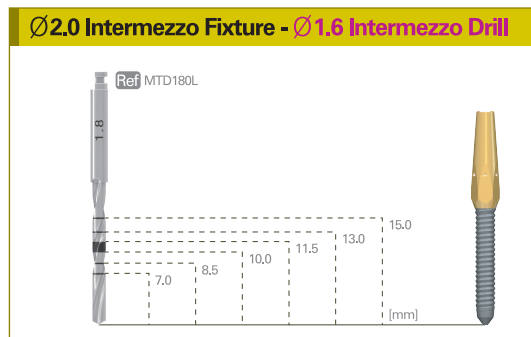
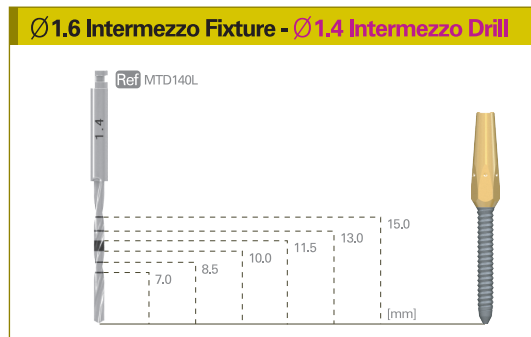

Recommended Instrument & Insertion Torque				
Fixture Diameter	Ø1.6	Ø2.0	Ø2.5	Ø3.1
Insertion Instrument	Hand Driver	Hand Driver Handpiece	Handpiece	
Insertion Torque	Under 20N·cm	Under 45N·cm	Under 45N·cm	

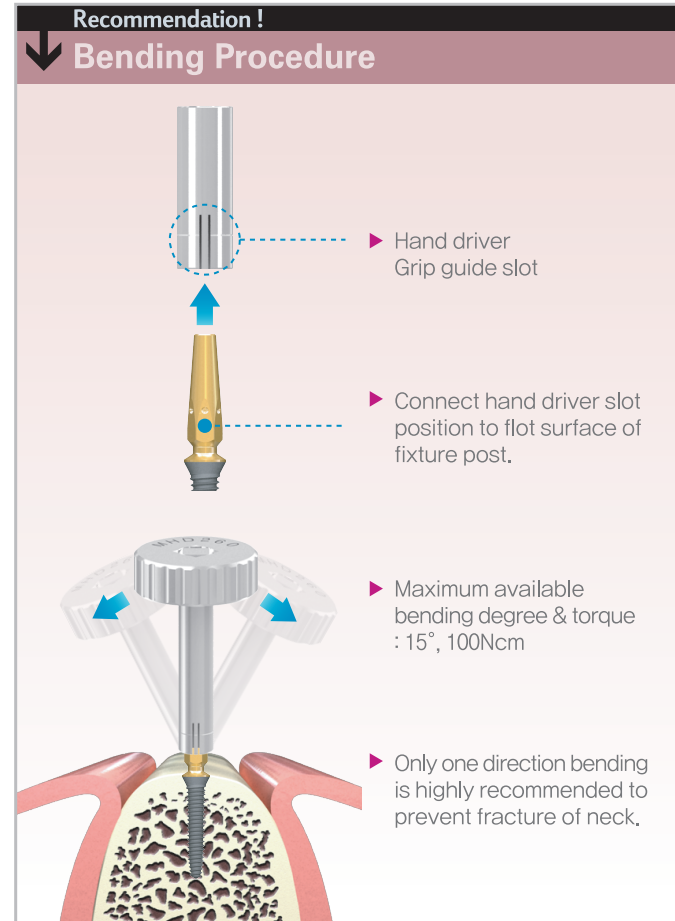

Intermezzo™ Implant System

Solid Cap	Snap Impression Coping	Lab Analog
<p>Ref IMPC100</p>	<p>Ref IMIC100</p>	<p>for Ø1.6 & 2.0 Fixture</p> <p>Ref AIMFA1620</p>
<p>Easy Temporary Crown Making ...</p> <p>* Use comfort cap to make temporary abutment at chair side.</p>		<p>for Ø2.5 & 3.1 Fixture</p> <p>Ref AIMFA2531</p>

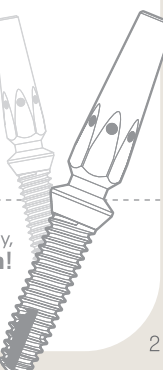



■ Intermezzo Fixture

Fixture		
Ref. Code	Description	Page
IMTI1607	Ø1.6 x L7.0mm / 7.0	p1
IMTI1608	Ø1.6 x L8.5mm / 8.5	
IMTI1610	Ø1.6 x L10.0mm / 10.0	
IMTI1611	Ø1.6 x L11.5mm / 11.5	
IMTI1613	Ø1.6 x L13.0mm / 13.0	
IMTI1615	Ø1.6 x L15.0mm / 15.0	
IMTI2007	Ø2.0 x L7.0mm / 7.0	p1
IMTI2008	Ø2.0 x L8.5mm / 8.5	
IMTI2010	Ø2.0 x L10.0mm / 10.0	
IMTI2011	Ø2.0 x L11.5mm / 11.5	
IMTI2013	Ø2.0 x L13.0mm / 13.0	
IMTI2015	Ø2.0 x L15.0mm / 15.0	
IMTI2507	Ø2.5 x L7.0mm / 7.0	p1
IMTI2508	Ø2.5 x L8.5mm / 8.5	
IMTI2510	Ø2.5 x L10.0mm / 10.0	
IMTI2511	Ø2.5 x L11.5mm / 11.5	
IMTI2513	Ø2.5 x L13.0mm / 13.0	
IMTI2515	Ø2.5 x L15.0mm / 15.0	
IMTI3107	Ø3.1 x L7.0mm / 7.0	p1
IMTI3108	Ø3.1 x L8.5mm / 8.5	
IMTI3110	Ø3.1 x L10.0mm / 10.0	
IMTI3111	Ø3.1 x L11.5mm / 11.5	
IMTI3113	Ø3.1 x L13.0mm / 13.0	
IMTI3115	Ø3.1 x L15.0mm / 15.0	

■ Instrument

Tool		
Ref. Code	Description	Page
MGD100L	Lance Drill	p2
MTD140L	Intermezzo Drill / D 1.4 / Long	p2
MTD180L	Intermezzo Drill / D 1.8 / Long	
MTD200L	Intermezzo Drill / D 2.0 / Long	
MTD260L	Intermezzo Drill / D 2.6 / Long	
MICD250	Countersink	p2
MHDR260	Hand Driver Ring	p2
MHD260	Hand Driver / Long	
MHD260S	Hand Driver / Short	
MIHC100	Handpiece Connector	p2

■ Abutment

Component		
Ref. Code	Description	Page
IMPC100	Solid Cap	p2
IMIC100	Snap Impression Coping	p2
AIMFA1620	Lab Analog for Ø1.6, Ø2.0 Fixture	p2
AIMFA2531	Lab Analog for Ø2.5, Ø3.1 Fixture	



Customer Service

[HEAD OFFICE] www.imegagen.com

MEGAGEN IMPLANT CO.,LTD

472, HANJANGGUN-RO, JAIN-MYUN, GYEONGSAN, GYEONGBUK, KOREA, 712-852
5F MegaGen Tower, 607 Seolleung-ro, Gangnam-gu, Seoul, Korea
Tel: 82-53-857-5770
Fax: 82-53-857-5432
E-mail: sales@imegagen.com

[Megagen USA INC.] / USA

440 Sylvan Ave. Suite 200 Englewood Cliffs, NJ 07632, USA
Tel : (+1)866-277-5662
E-mail : info@megagenus.com

[ISG Dental GmbH] / Austria

Wiegelestrasse 10, 1230 Vienna, AUSTRIA
Tel : (+43)1869-3220
E-mail : r.schultschik@isg-gmbh.at

[Implant2dentist] / Denmark

Tandlaegerne i kogade I/S Kogade 4 6270 Toender Denmark
Tel : (+45)7010-8700, (+45)2835-5459
E-mail : mikkelro@implant2dentist.dk

[Megagen Hellas LTD] / Greece

19th G. Papandreou Str., 15773 Zografou, Athens, GREECE
Tel : (+30)21-0748-5533, (+30)21-0748-5544
E-mail : george.kouratiadis@dentomedica.gr

[MegaGen Italia S.R.L.] / Italy

VIA MAZZINI 43/b - 22030 Pusiano (Co), ITALY
Tel : (+39)34-8085-5432
E-mail : info@megagenitalia.it

[UAB "ImplaMedica"] / Lithuania

Kalvariju 272, LT-08316 Vilnius, Republic of Lithuania
Tel : (+37)5219-5971
E-mail : info@implamedica.lt

[MegaGen Benelux b.v.] / Netherlands

Prof. Cobbenhagenlaan 99, 5037 DB Tilburg, The Netherlands
Tel : (+31)8-8848-4100, (+31)6-2000-9582
E-mail : info@megagenbenelux.nl

[Megagen Portugal Lda] / Portugal

Rua dos Açores 67, 4430-643 Vila Nova de Gaia, Portugal
Tel : (+351)2-2488-4026
E-mail : geral@megagen.pt

[MEGAGEN DENTAL IMPLANT] / Romania

STR. Mamulari nr.4, BIC2, sc.2, ap.37 sec.3, Bucuresti
Tel : (+40)3-1418-1238
E-mail : ciprian.amarandei@megagen.ro

[Createch Medical SL] / Spain

Pol. Kurutz Gain, Pab 3 20850 Mendaro (Guipúzcoa), Spain
Tel : (+34)9-4375-7172
E-mail : createch@createchmedical.com

[Orexa Dental AB] / Sweden

Berggrensgatan 8, 412 73 Gothenburg, Sweden
Tel: (+46)709-208000
E-mail : info@orexa.se

[Megagen Implants UK] / United Kingdom

Hemel Business Centre Westside, London Road Apsley Hemel Hempstead Herts HP3 9TD UK
Tel : (+44)14-4284-0326
E-mail : dima.corduneanu@megagen.co.uk

[Abtin Pezeshk Abzar Co.] / Iran

Unit 12, 3th Floor, building pezashkan sabz 2 (No8), Imam zadeh Alley, Opposite Dowlat St,Shariati,Tehran-Iran
Tel : (+98)21-26600568-70 / Fax : (+98)21-22612438
E-mail : apaco2010@ymail.com

[MANDALE HEALTHCARE] / Iraq

Kurdistan region, Sulimanya city, end of Goran street, Salim Bag Building, floor 4, Flat No.1
Tel : (+09)6477-0146-6409
E-mail : yankialawi@yahoo.com

[IMPLAMEDICA] / Lebanon

Implamedica est Centre St. Georgers, Adonis, 4th floor, Lebanon
Tel : (+961)7085-5249; (+961)7001-5532
E-mail : info@megagenlebanon.com

[Dental Guru] / Russia

Bld 43/2, Pokrovka Str. Moscow, 105062, Russia
Tel : (+7)92-6526-2697
E-mail : implantguru@gmail.com

[SAMD Company] / Saudi Arabia

P.O. Box : 381182 Riyadh. 11345, Kingdom of Saudi Arabia
Tel : (+96)6-1431-1188
E-mail : samdcomp@gmail.com

[MegaGen Turkiye] / Turkey

Gulbahar Mah. Buyukdere Cad. No:99 D:7, Mecidiyekoy, Istanbul Turkey
Tel : (+90)21-2211-3932
E-mail : info@megagen.com.tr

[Ningbo Megagen China] / China

No.456 Tonghui road, Jiangbei Inverstment&Pioneering (Park C), Ningbo
Tel : (+86)574-2770-9928
E-mail : megagen@hotmail.com

[MegaGen Hong Kong Ltd] / Hong Kong

Room 604D, InnoCentre 72 Tat Chee Avenue, Kowloon Tong Kowloon, Hong Kong
Tel : (+852)2866-0199
E-mail : megagenhk@gmail.com

[SREE Implantology Solutions India Private limited] / India

D.No.48-12-11B, F.No.201, CBR Residency, Eluru Road, Gunadala, BesideTelephoneExchange,
Vijayawada-520005, AndhraPradesh, INDIA
Tel : (+91)99-6623-8456
E-mail : info@sreeimplants.com

[Dental Solutions & Services Pte Ltd] / Singapore

Blk 28 kallang place #05-16 Singapore 339158 / www.dentalsolutions.sg
Tel : (+65)9147-4633
E-mail : andy.poh@dentalsolutions.sg

[Sunriser Medical] / Taiwan

5 SEC., CHUNG-HSIAO E.RD NANGANG DISTRICT., TAIPEI, TAIWAN 115
Tel : (+88)6-2-27881335
E-mail : sunrise.medical@msa.hinet.net

[Dental-Siam Enterprise Co., Ltd] / Thailand

54 Soi Phanit-Anan, Sukhumvit 71 Road., Klongton Nua, Wattana, BKK 10110 Thailand
Tel : (+66)2713-3355 Ext. 300
E-mail : Praphaporn@dental-siam.co.th

